

23 cm PAs with MRFE6S9160: from 150 W up to 1 kW

Wolf-Henning Rech
DF9IC
Eisinger Str. 36/2
D-75245 Neulingen
Germany

JN48iw

<http://www.df9ic.de>



LDMOS: „full legal power“ ?



- Popular LDMOS amplifier modules (pallets):
 - 144 MHz: 1 kW LDMOS MRFE6VP61K25
 - 432 MHz: 500 W MRFE6VP5600
 - 1296 MHz: 150 W 2 x MRF286

Pallets without a shielding box

- OK for a prototype – but not for a product

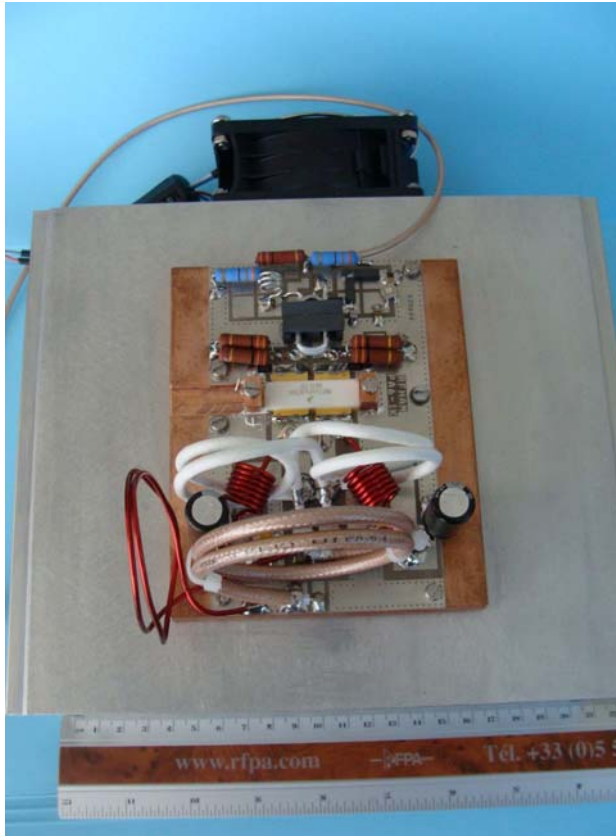

Nordic VUSHF 2016 Sappee

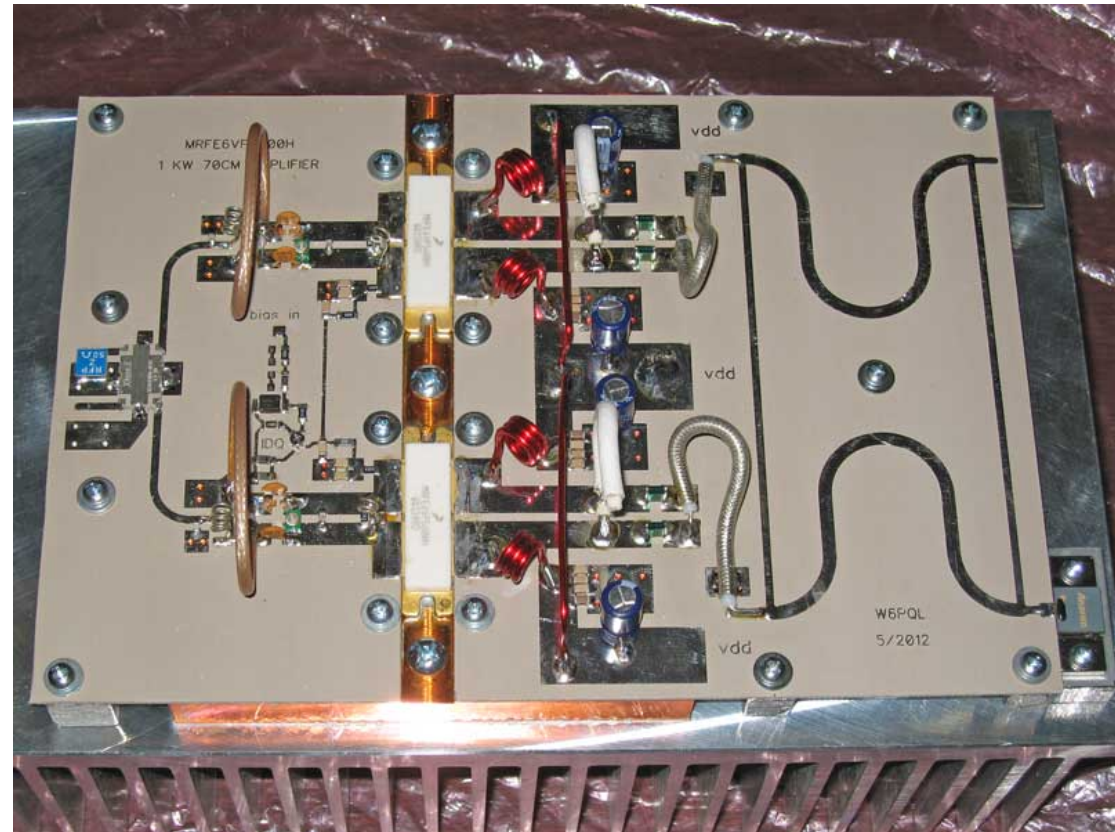

Wolf-Henning Rech DF91C

PAs based on such pallets

- Imperfectly shielded outer enclosures



Nordic VUSHF 2016 Sappee



Wolf-Henning Rech DF91C

Module concept



- Use of a cheap shielding box, to be integrated with a large heat spreader
- Low cost LDMOS surplus transistors (from cellular, not broadcast market)
- Expensive components only where really needed (but reliable design nevertheless)

Concept of the box

- Transistor is installed on a copper heat spreader
- Frame and cover from tin plated material (possibly joint with the heat spreader)
- PCB fixed with screws to the copper and soldered to the tin plate frame



Concept of the box

- Two separate PCBs for input and output circuits
- As few through-holes as possible

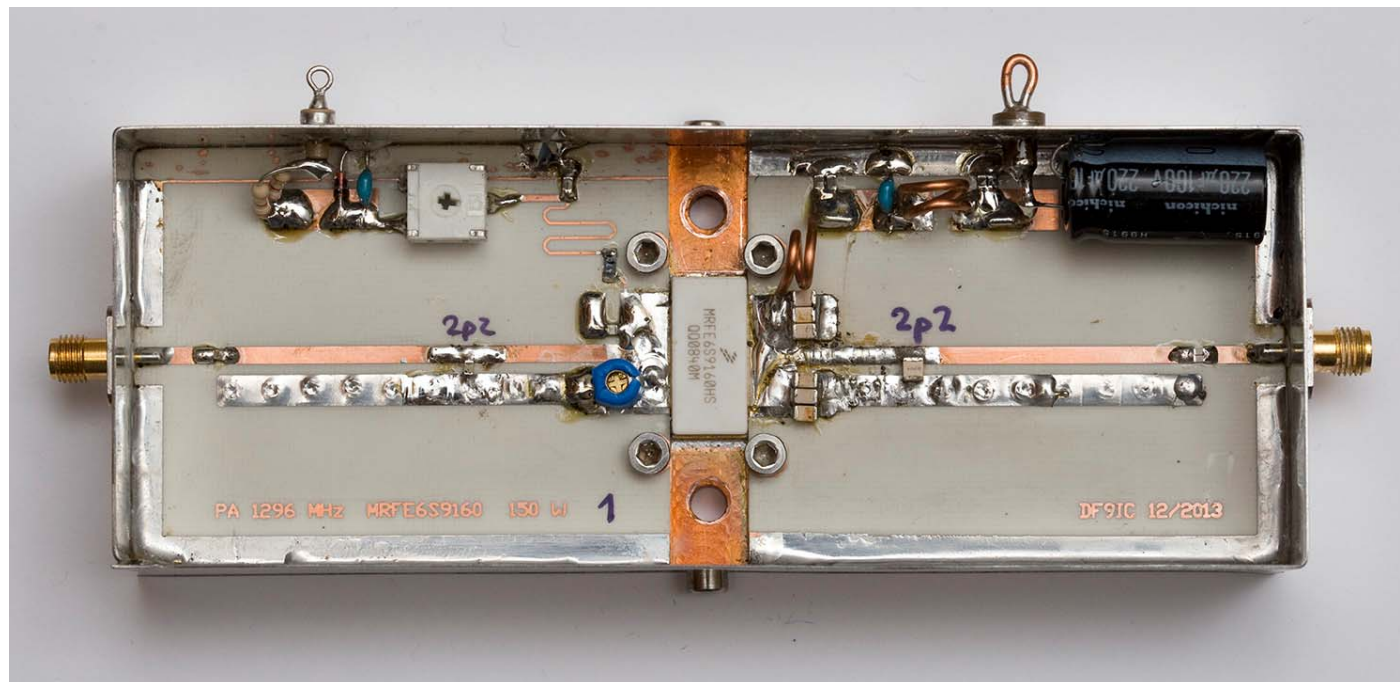

High-current feedthrough

- Feedthrough capacitors for 10-25 A



Nordic VUSHF 2016 Sappee



Wolf-Henning Rech DF91C

Which transistors for 1296 MHz?



- Cellular transistors for 900 MHz 60 W:
MFR9060, MRF6S9060, MRF286 etc.
(without internal pre-matching)
- Broadcast/ISM transistors for 1300/1400 MHz
(internally pre-matched):
PTF141501E 150 W 28 V
BLF6G13L-250P 250 W 50 V
- Cellular transistors for 900 MHz 125...160 W:
MRFE6S9125, MRFE6S9135, MRFE6S9160
(only pre-matched at the input)

My preferred 23 cm PA transistor

Freescale Semiconductor
Technical Data

Document Number: MRFE6S9160H
Rev. 1, 12/2008



RF Power Field Effect Transistors N-Channel Enhancement-Mode Lateral MOSFETs

Designed for N-CDMA, GSM and GSM EDGE base station applications with frequencies from 865 to 960 MHz. Suitable for multicarrier amplifier applications.

- Typical Single-Carrier N-CDMA. Performance @ 880 MHz: $V_{DD} = 28$ Volts, $I_{DQ} = 1200$ mA, $P_{out} = 35$ Watts Avg., IS-95 CDMA (Pilot, Sync, Paging, Traffic Codes 8 Through 13) Channel Bandwidth = 1.2288 MHz. PAR = 9.8 dB @ 0.01% Probability on CCDF.
Power Gain — 21 dB
Drain Efficiency — 31%
ACPR @ 750 kHz Offset — -46.8 dBc in 30 kHz Bandwidth
- Capable of Handling 10:1 VSWR, @ 32 Vdc, 880 MHz, 3 dB Overdrive, Designed for Enhanced Ruggedness.

Features

- Characterized with Series Equivalent Large-Signal Impedance Parameters
- Internally Matched for Ease of Use
- Qualified Up to a Maximum of 32 V_{DD} Operation
- Integrated ESD Protection
- RoHS Compliant
- In Tape and Reel. R3 Suffix = 250 Units per 56 mm, 13 inch Reel.

MRFE6S9160HR3
MRFE6S9160HSR3

880 MHz, 35 W AVG., 28 V
SINGLE N-CDMA
LATERAL N-CHANNEL
RF POWER MOSFETs

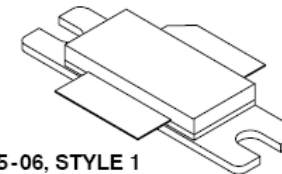

CASE 465-06, STYLE 1
NI-780
MRFE6S9160HR3

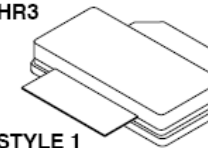

CASE 465A-06, STYLE 1
NI-780S
MRFE6S9160HSR3

MRFE6S9160HS – 10 EUR

www.ebay.fr/itm/10PCS-MRFE6S9160HS-Encapsulation-RF-TRANSISTOR-RF-Power-Field-Effect-/371081117939?pt=L

Nous utilisons des cookies pour optimiser votre expérience sur notre site. En utilisant eBay, vous acceptez que nous appliquions des cookies.

Bienvenue | Connectez-vous ou inscrivez-vous | Promotions | Vendre | Aide

Rechercher... Toutes les catégories Rechercher Recherche approfondie

Retourner à la page d'accueil | Catégorie de mise en vente : Business & Industrial > Electrical & Test Equipment > Electronic Components > Passive Components > Other

10PCS MRFE6S9160HS Encapsulation:RF TRANSISTOR,RF Power Field Effect

Etat : Occasion

Quantité : Plus de 10 disponibles
4 objets déjà vendus

108,33 USD
Environ 98,18 EUR

Achat immédiat

Ajouter au panier

- Ajouter à vos Affaires à suivre
- Ajouter à la collection

2 membres suivent la vente

Vendeur expérimenté

Vendeur Top Fiabilité
hksource (66457) 99,7% Evaluations positives

- Reçoit constamment d'excellentes évaluations de la part des acheteurs
- Envoie les objets rapidement
- Propose en permanence un service de qualité

S'abonner à ce vendeur
Afficher les autres objets

Visiter la Boutique : UTSOURCE STORE

Livraison : **4,00 USD (environ 3,63 EUR)** Economy Int'l Shipping | Détails
Cliquez ici pour plus de détails sur la livraison internationale.

Lieu où se trouve l'objet : SHENZHEN, Chine
Lieu de livraison : Monde entier | Afficher les exclusions

Délai de livraison : Estimé entre le **mar. 5 mai** et le **mar. 19 mai**
Le vendeur envoie l'objet 3 jours après avoir reçu le paiement.

Paiements : **PayPal**
Cartes de crédit traitées par PayPal
Afficher les informations de paiement

Retours : 14 derniers jours remboursement, l'acheteur paie les frais de retour | Détails

Couverture : **LIVRE OU REMBOURSE avec PayPal** Voir les conditions

PA 1296 MHz: the prototype

- Let's try it !

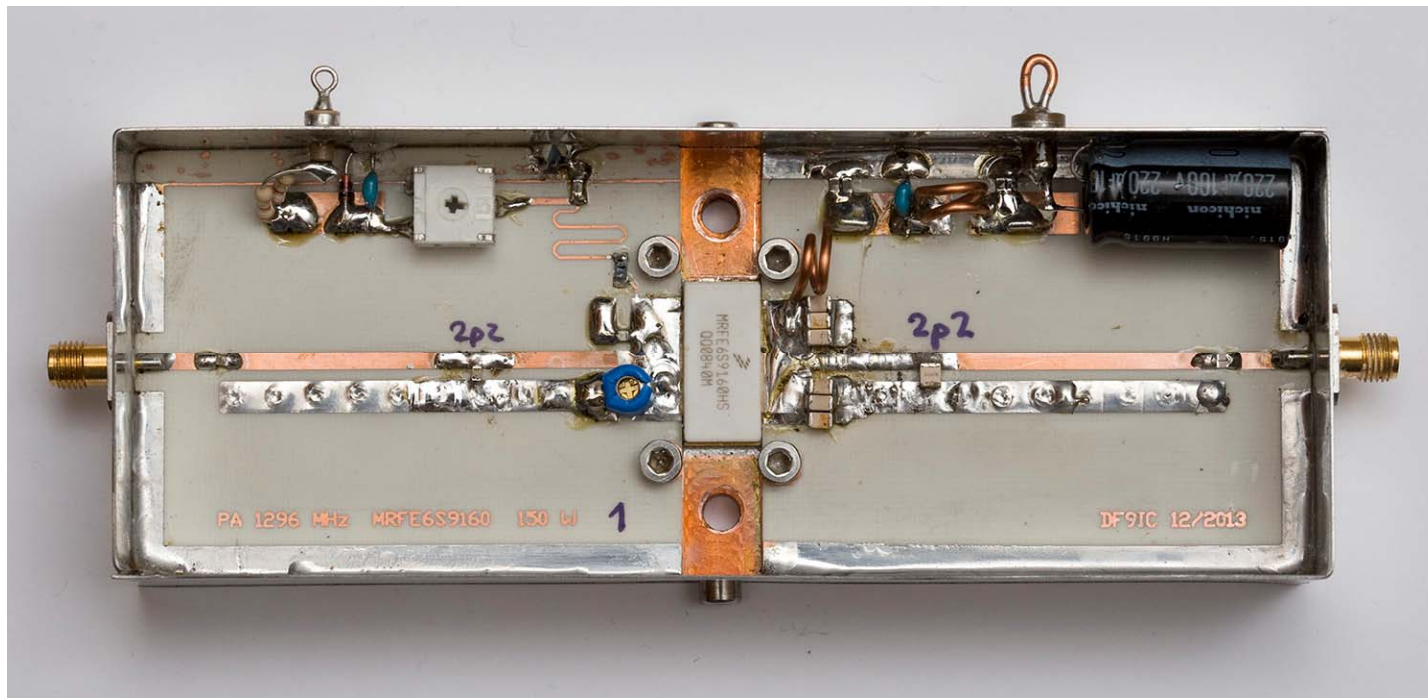

With success: 150 W output power at 19...20 dB gain

PA 1296 MHz: push-pull ?

- Experiment of a push-pull amplifier:



Poor result: asymmetric behaviour, low efficiency.

PA 1296 MHz: MRFE6S9160

- Design of an amplifier without through-holes close to the transistor:



Result: similar to the first prototype, but critical contacts at the PCB edges

PA 1296 MHz: MRFE6S9160

- Soldering of the transistor to the heat spreader: first trials with tin-lead solder

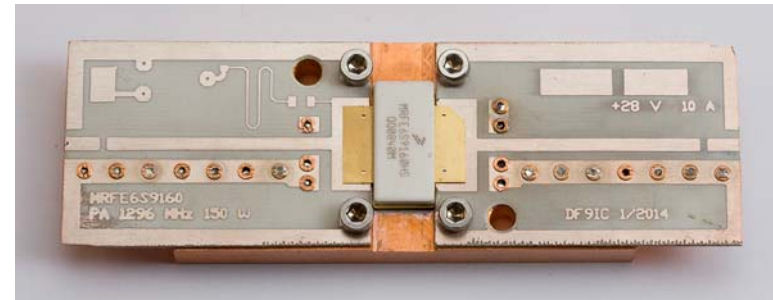
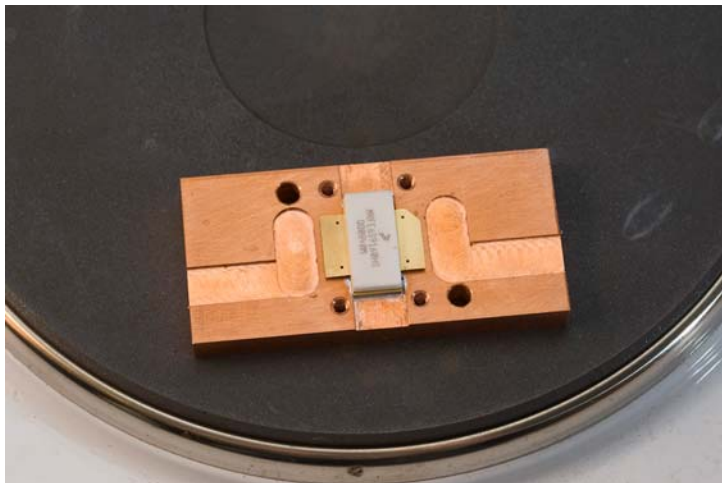
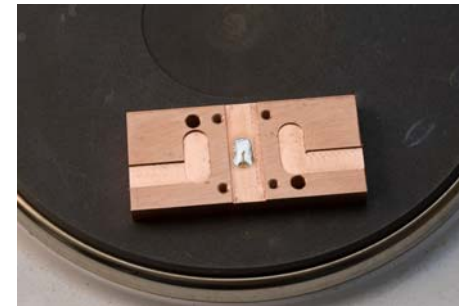
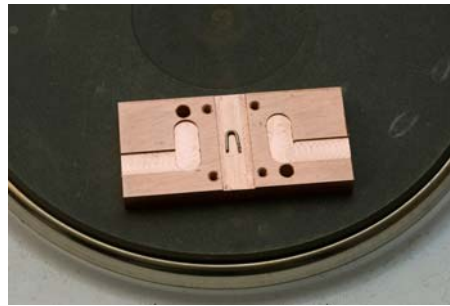

PA 1296 MHz: MRFE6S9160

- Result: this process was working, but caused several failures too (transistors had reduced transconductance)
- Then: use of a low temperature SMD solder paste - 138°C – Edsyn CR11 Sn42Bi58 (tin – bismuth)



- Slowly heating and cooling the pallets
=> no more failures (from 20 transistors)!

PA 1 x MRFE6S9160 RO4003

- Design verification with 4 new prototypes – all achieve >150 W at 28 V

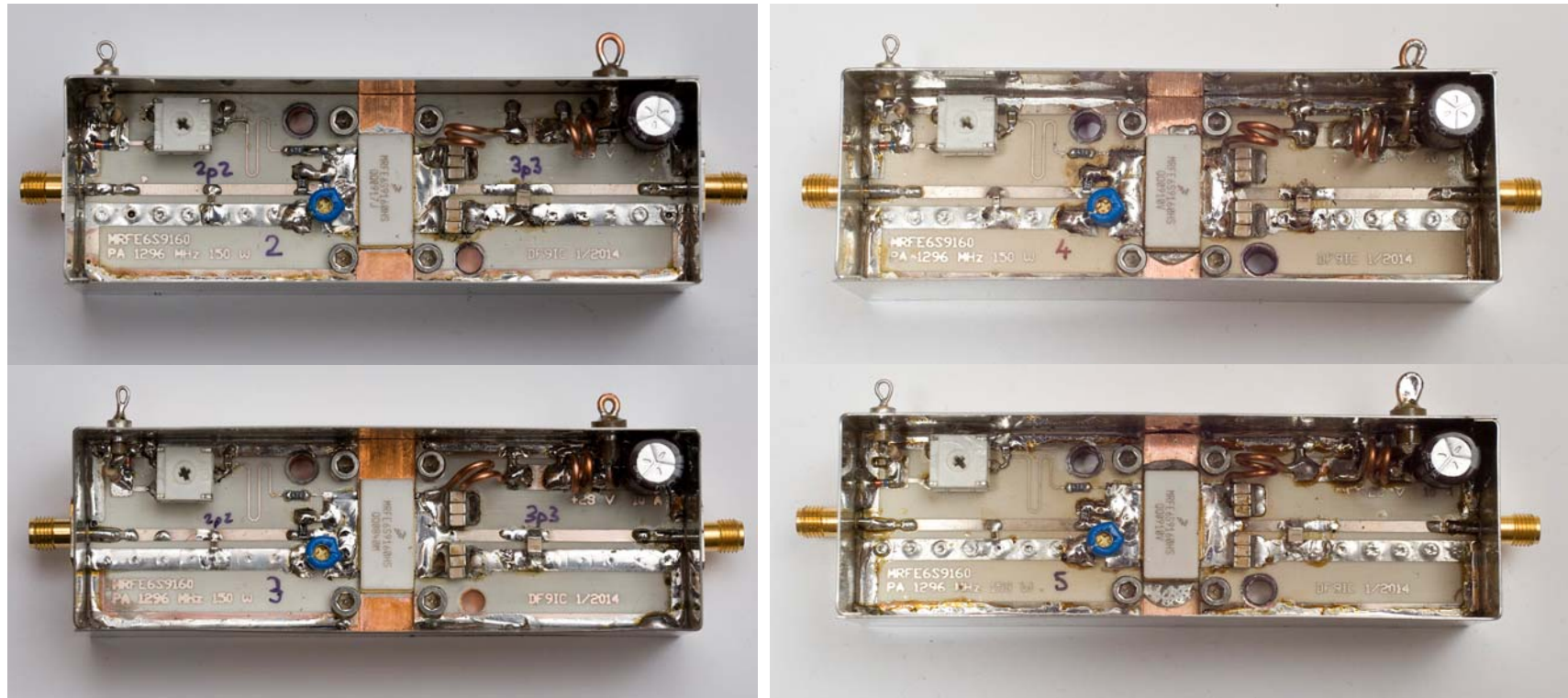

PA 1 x MRFE6S9160 RO4003

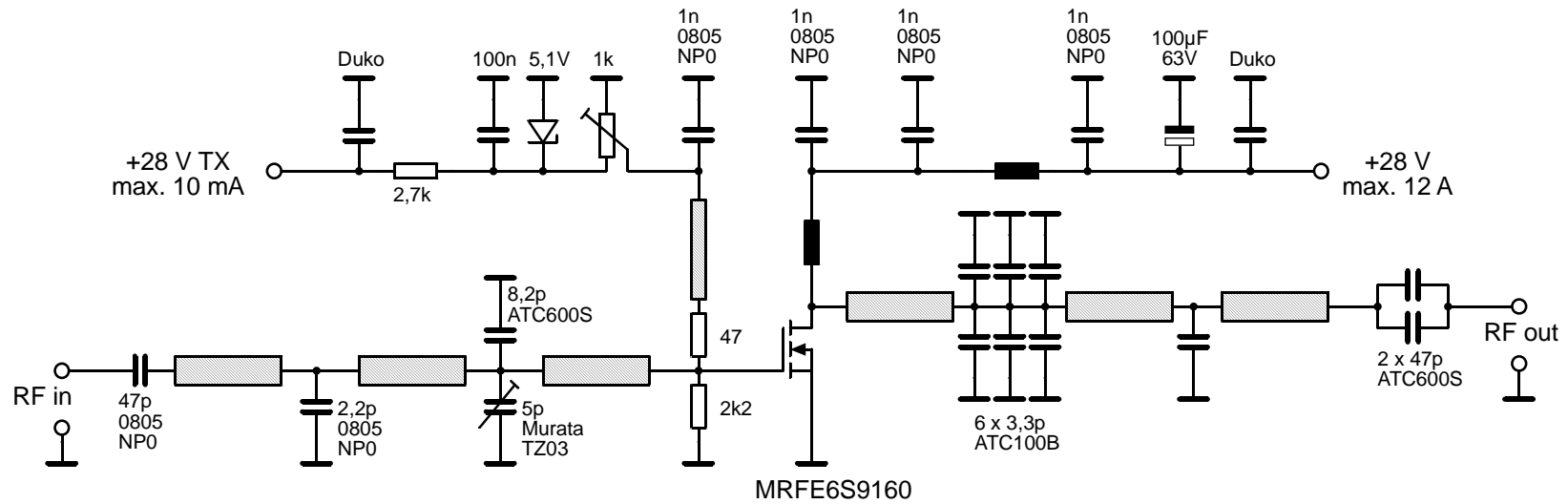

PA 1 x MRFE6S9160 RO4003

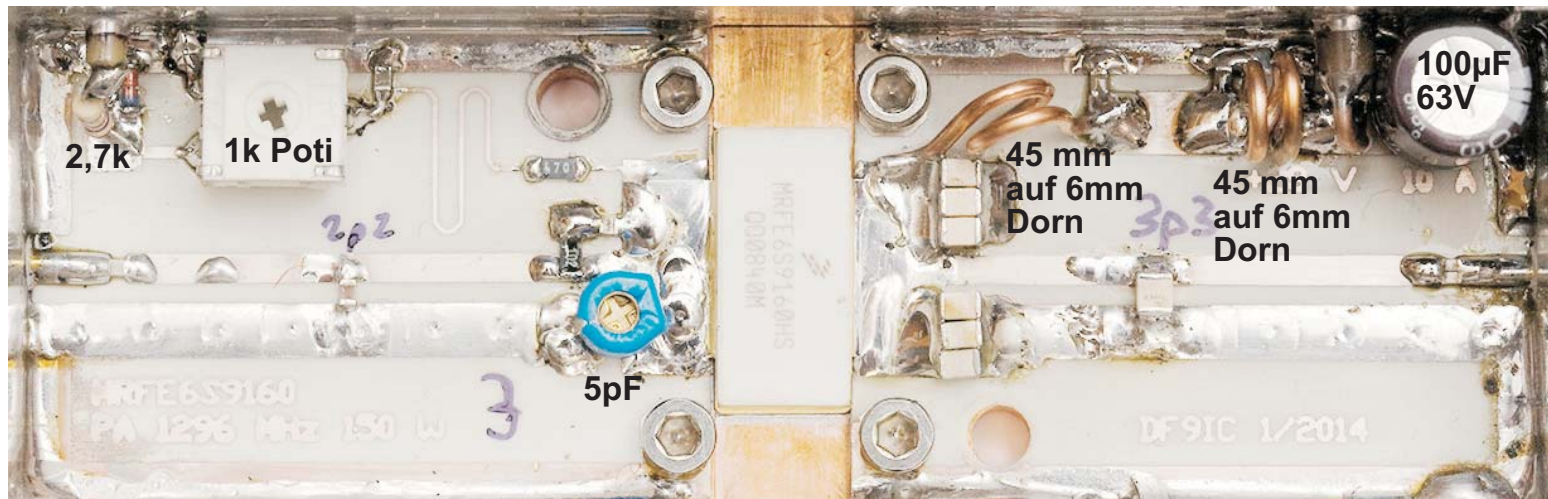
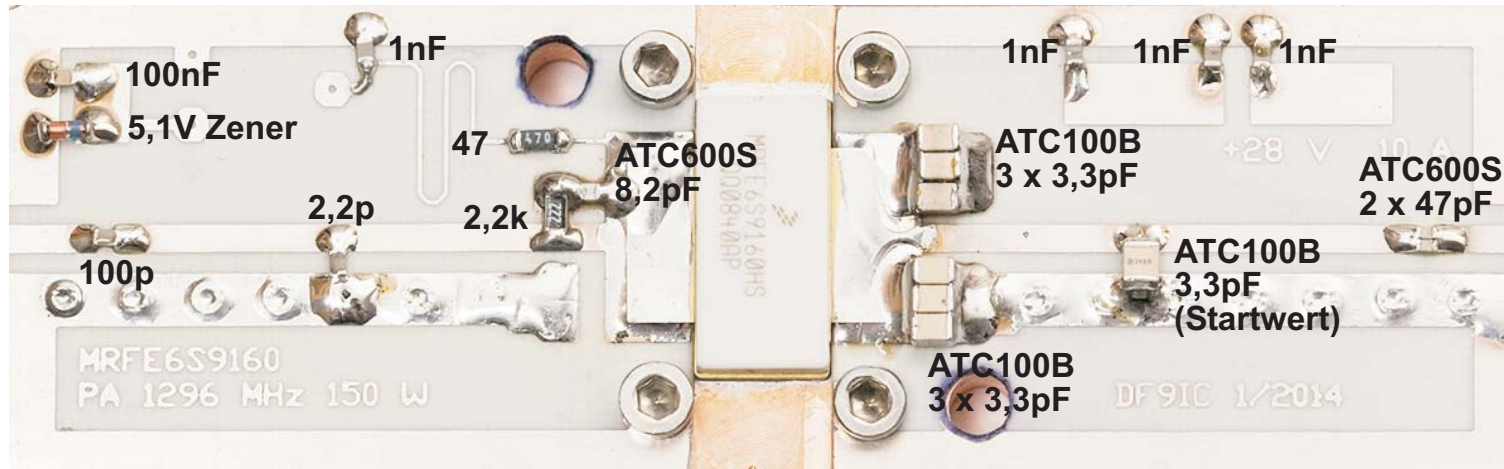

PA 1 x MRFE6S9160 RO4003

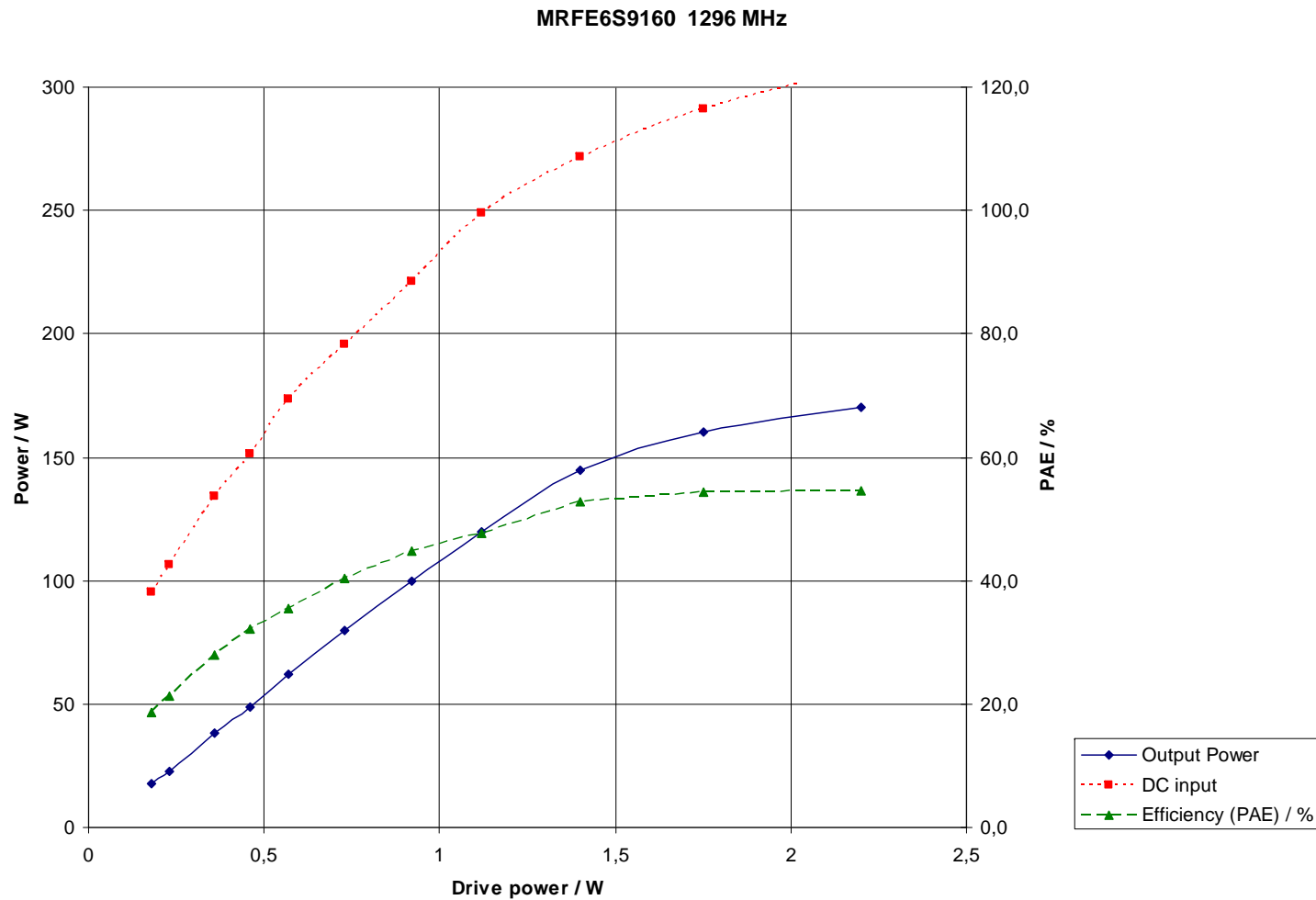

PA 1 x MRFE6S9160 FR4

- Another experiment on 1.5 mm FR4 substrate, as RO4003 is difficult to buy in small quantities

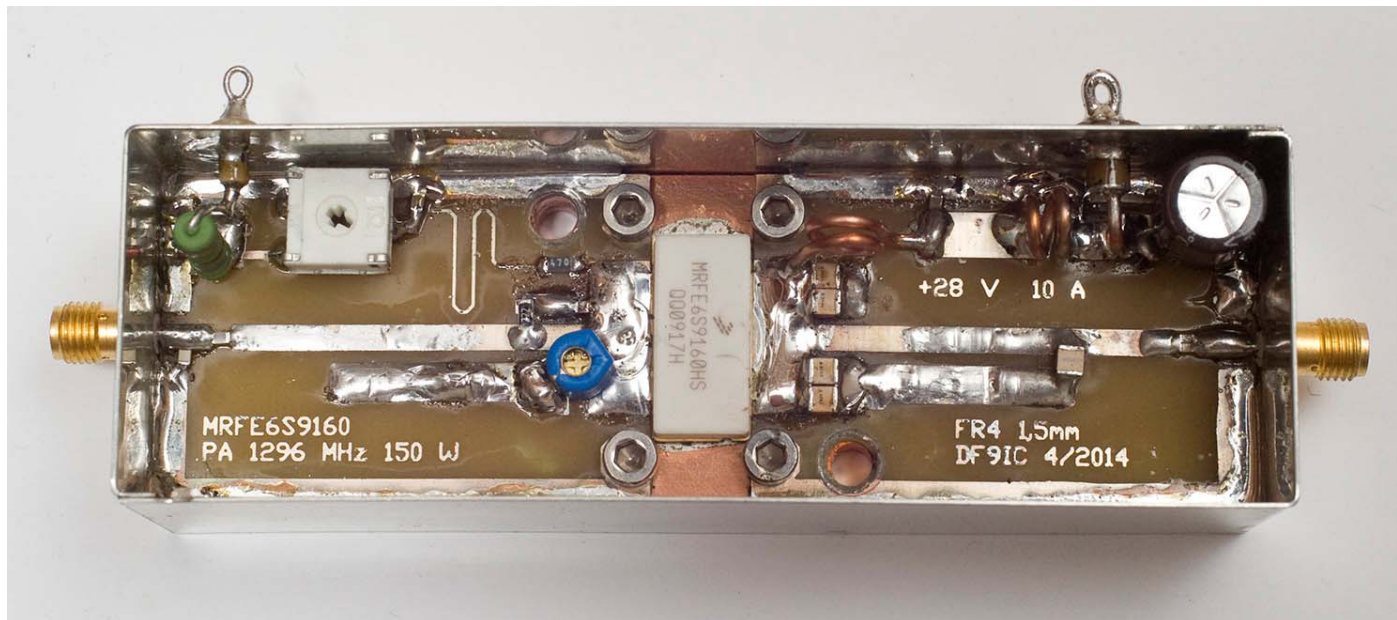

- The result is lower output power and reduced efficiency

PA 1 x MRFE6S9160 FR4

MRFE6S9160 1296 MHz

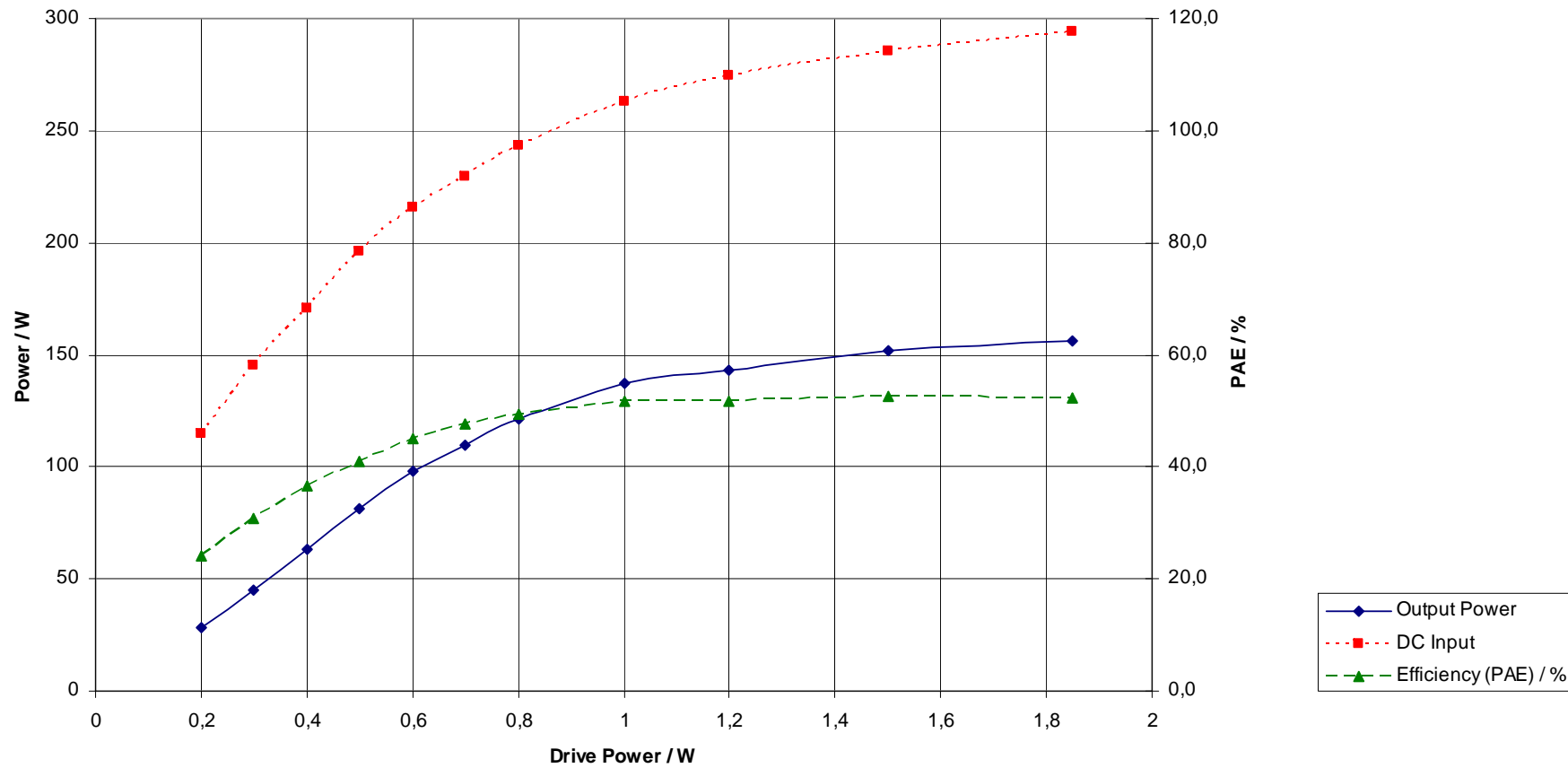

PA 2 x MRFE6S9160 R04003

- Next stage: coupling of two amplifiers

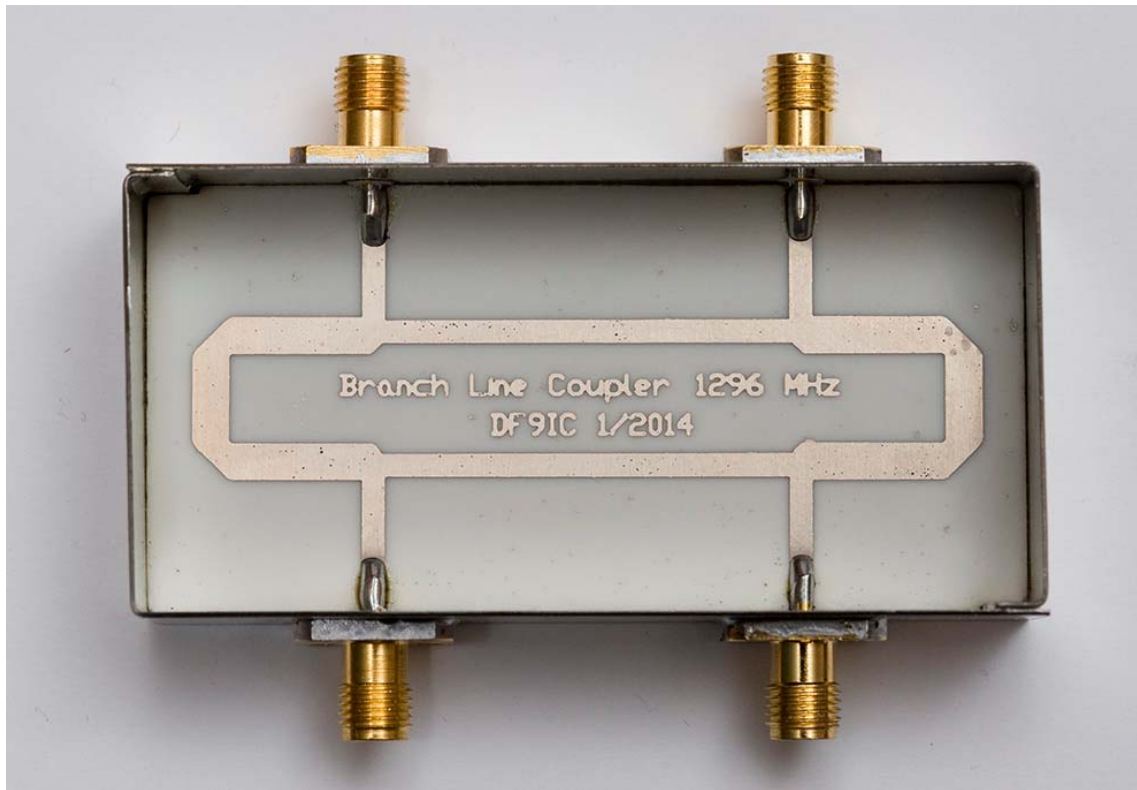

PA 1296 MHz: 2 x MRFE6S9160

- Prototype of the twin amplifier

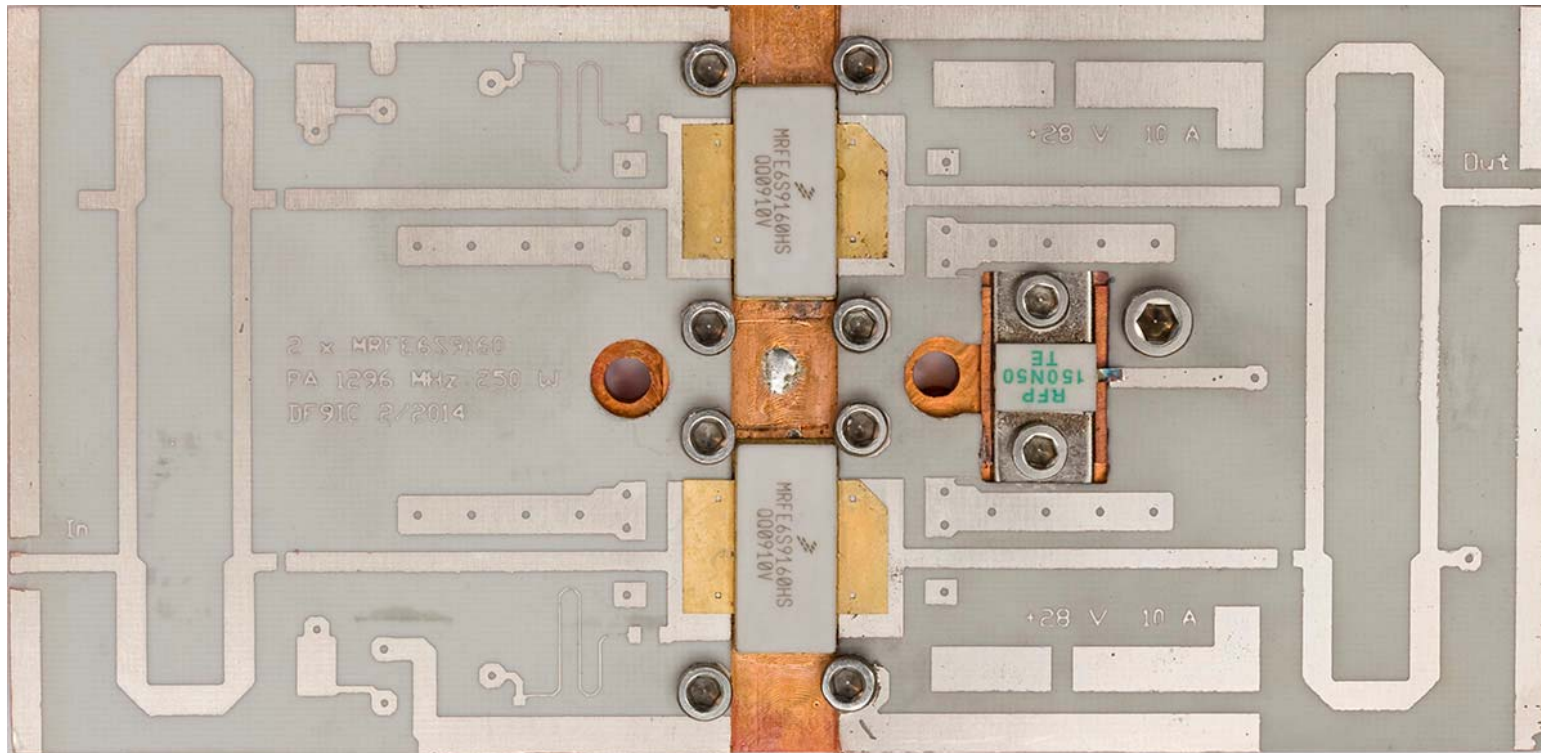

PA 1296 MHz: 2 x MRFE6S9160

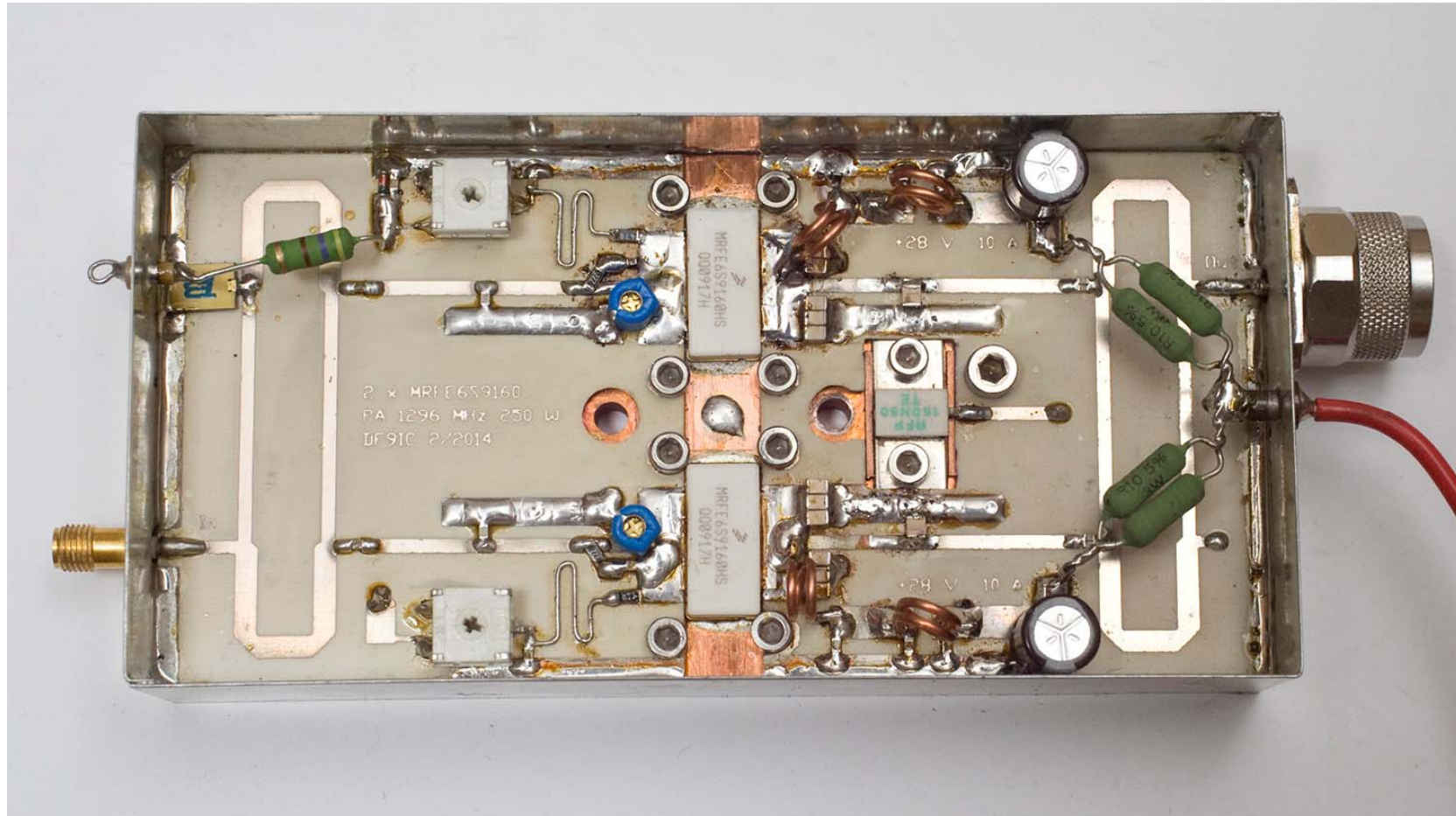

PA 1296 MHz: 2 x MRFE6S9160



- Result: success, nearly 300 W at 28 V, efficiency and gain bit lower than for the single amplifier
- Adjustment procedure: first supply and adjust each transistor single (resulting in 6 dB less gain and 3 dB less power than in a single amplifier); e. g. 5 W to 70 W
- then only minor fine adjustment necessary for the joint operation (expect 5 W to 280 W then, according to the above example)
- Next step: try to make PCB smaller and module simpler to build

PA 1296 MHz: 2 x MRFE6S9160

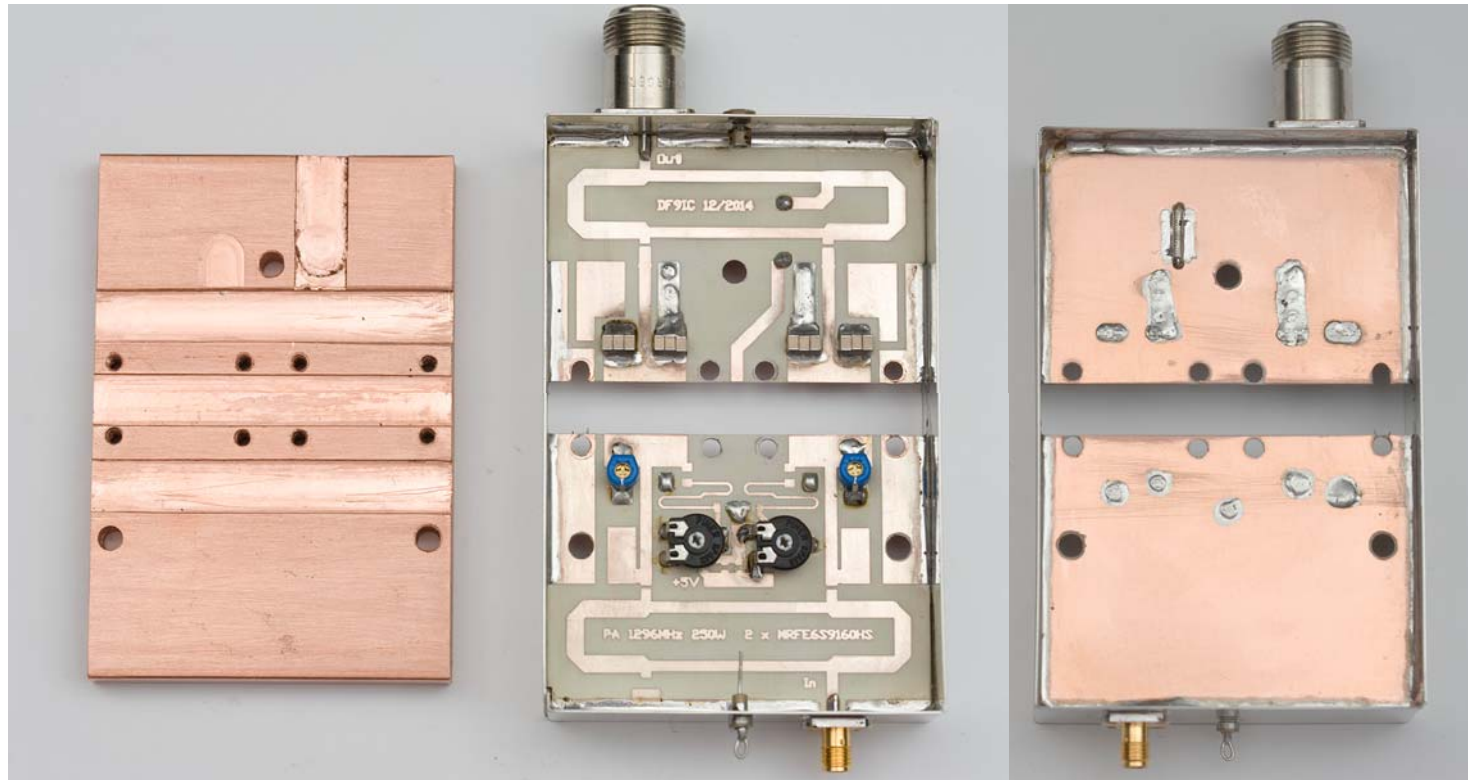

PA 1296 MHz: 2 x MRFE6S9160

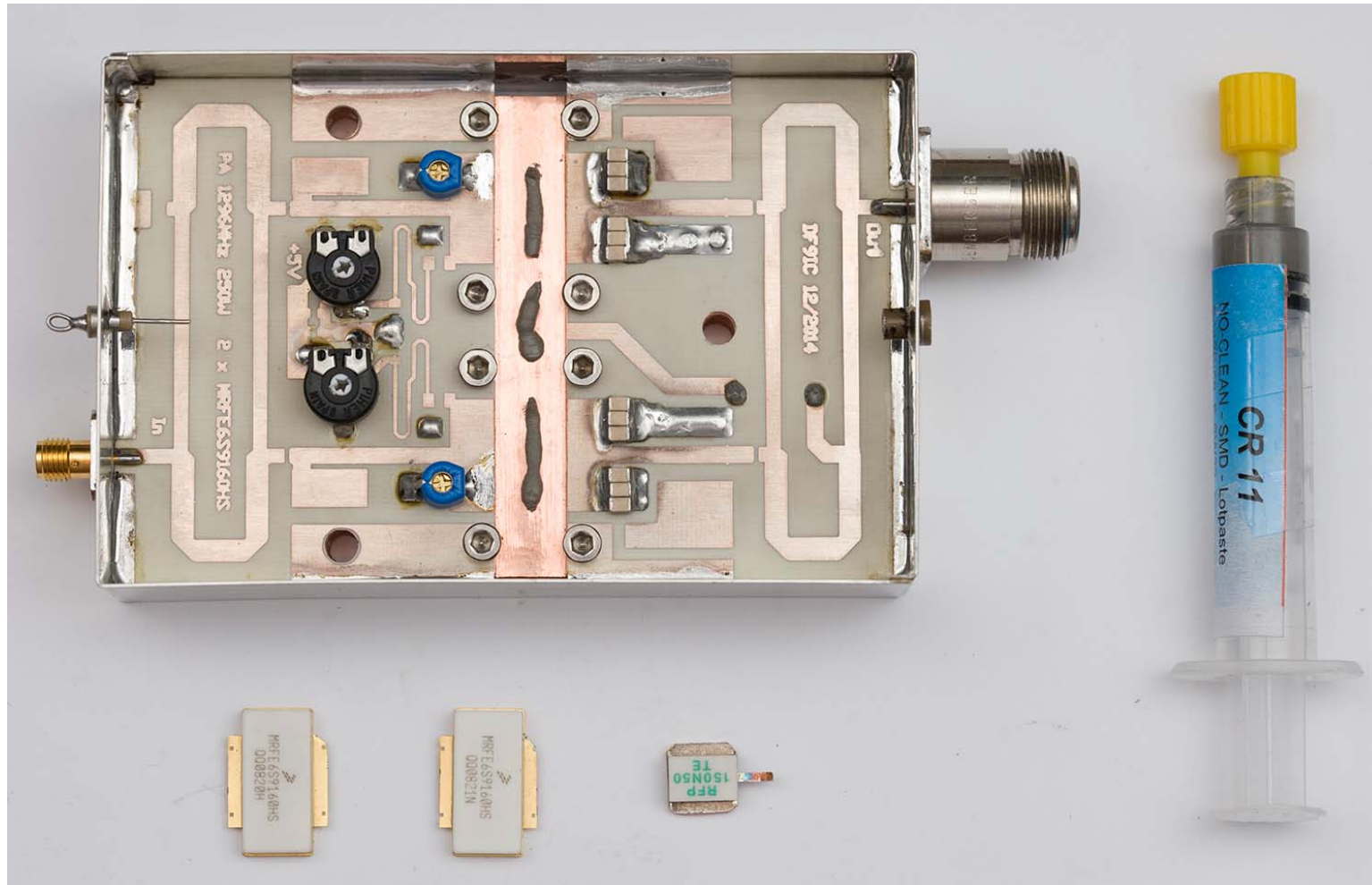

PA 1296 MHz: 2 x MRFE6S9160

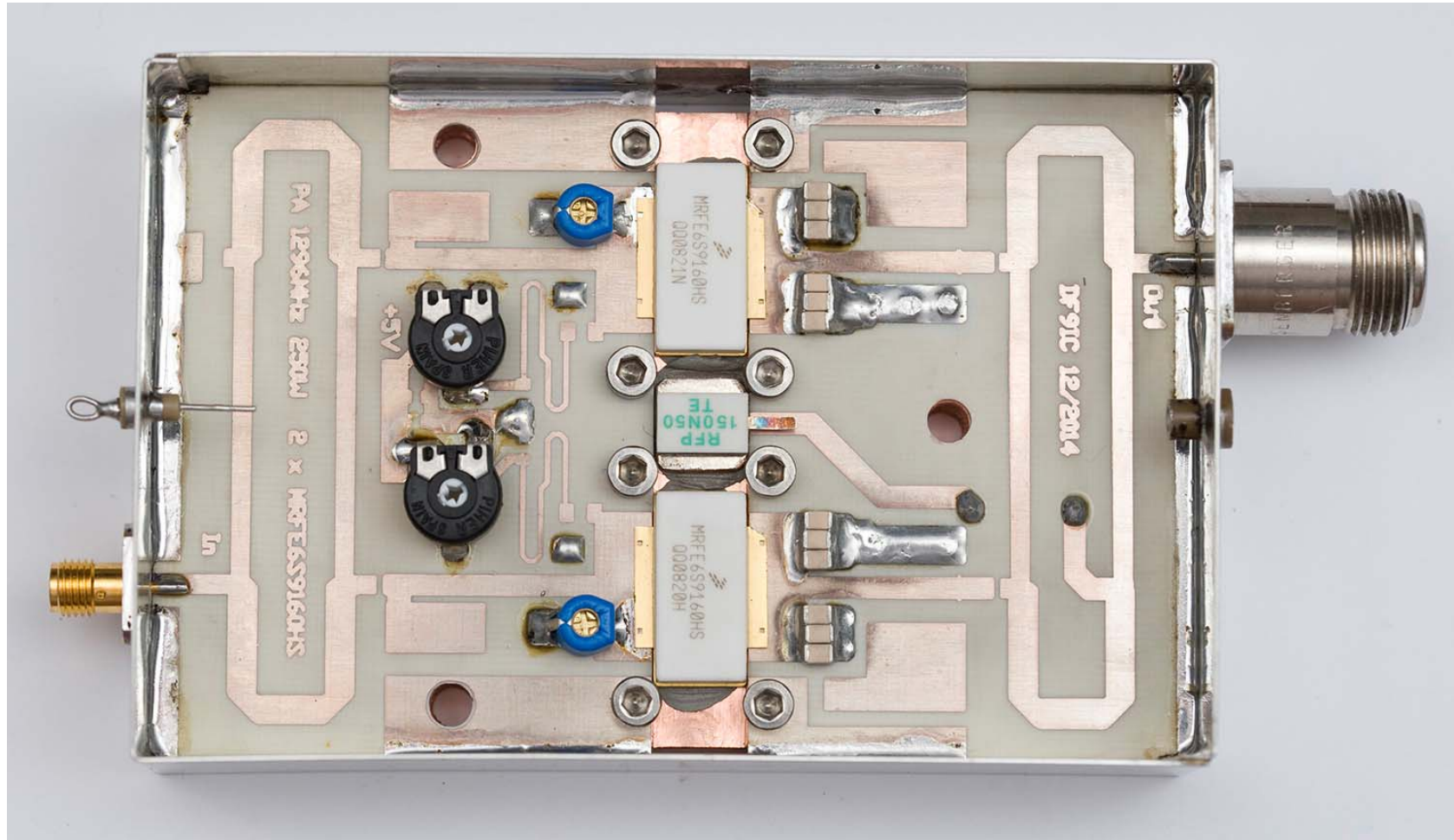

PA 1296 MHz: 2 x MRFE6S9160

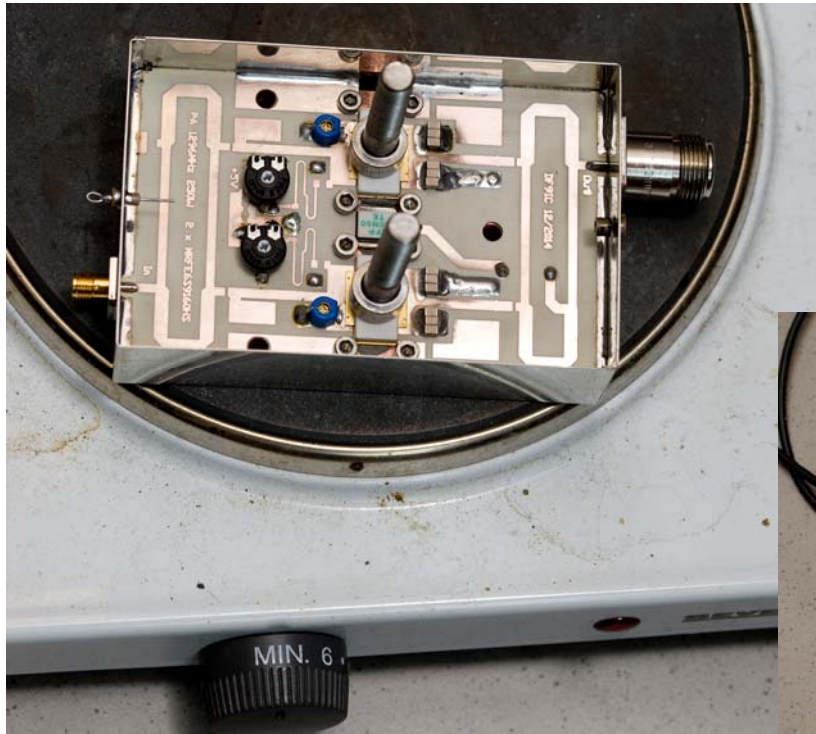

Nordic VUSHF 2016 Sappee

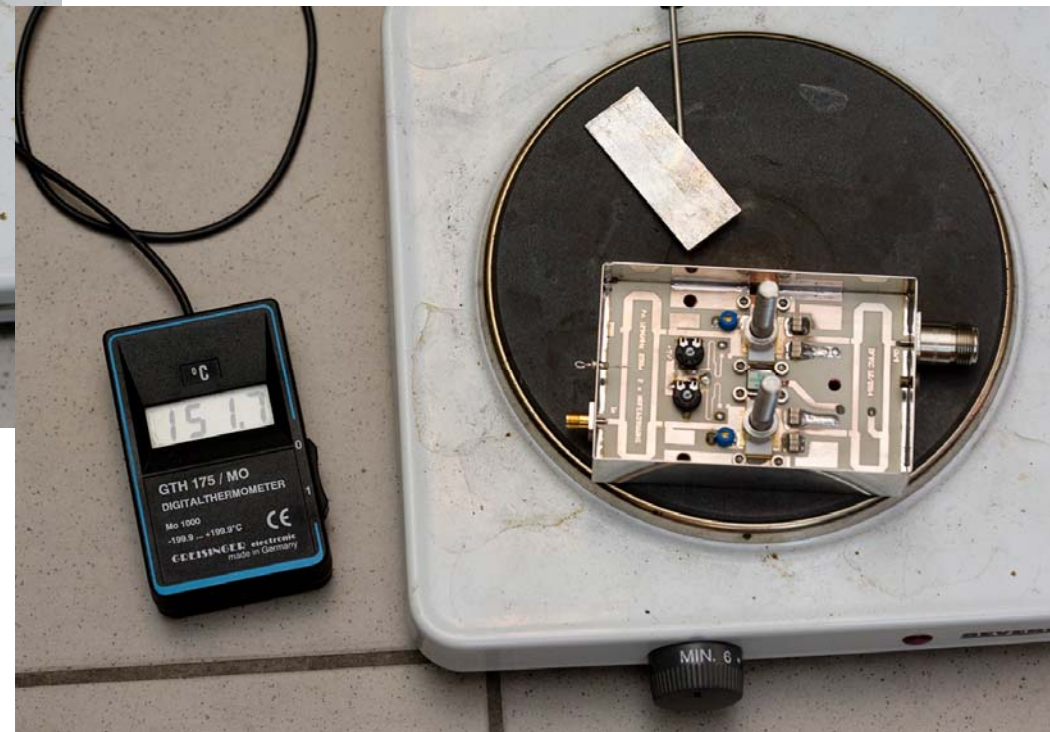

Wolf-Henning Rech DF91C

PA 1296 MHz: 2 x MRFE6S9160



PA 1296 MHz: 2 x MRFE6S9160

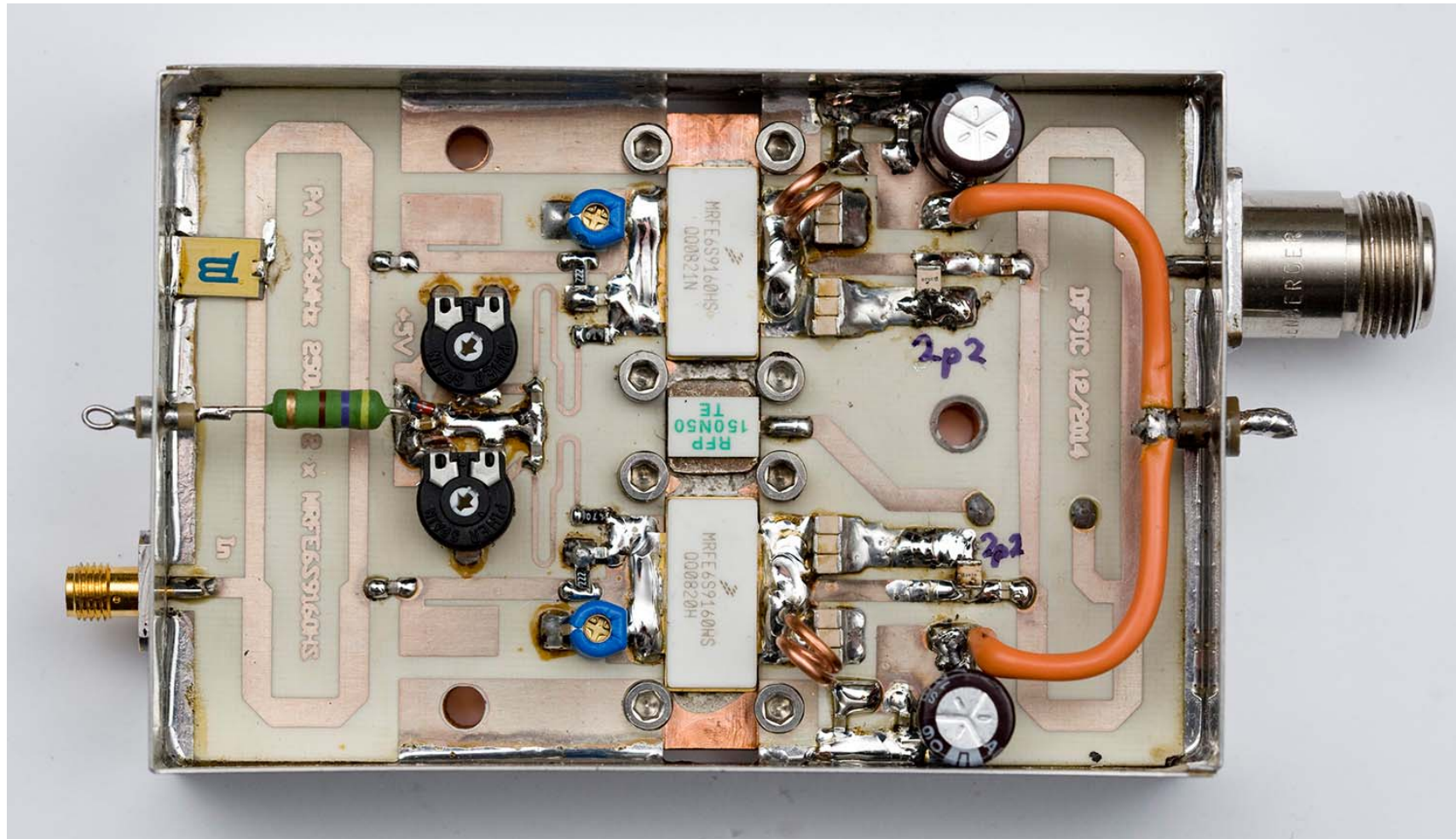

PA 1296 MHz: 2 x MRFE6S9160

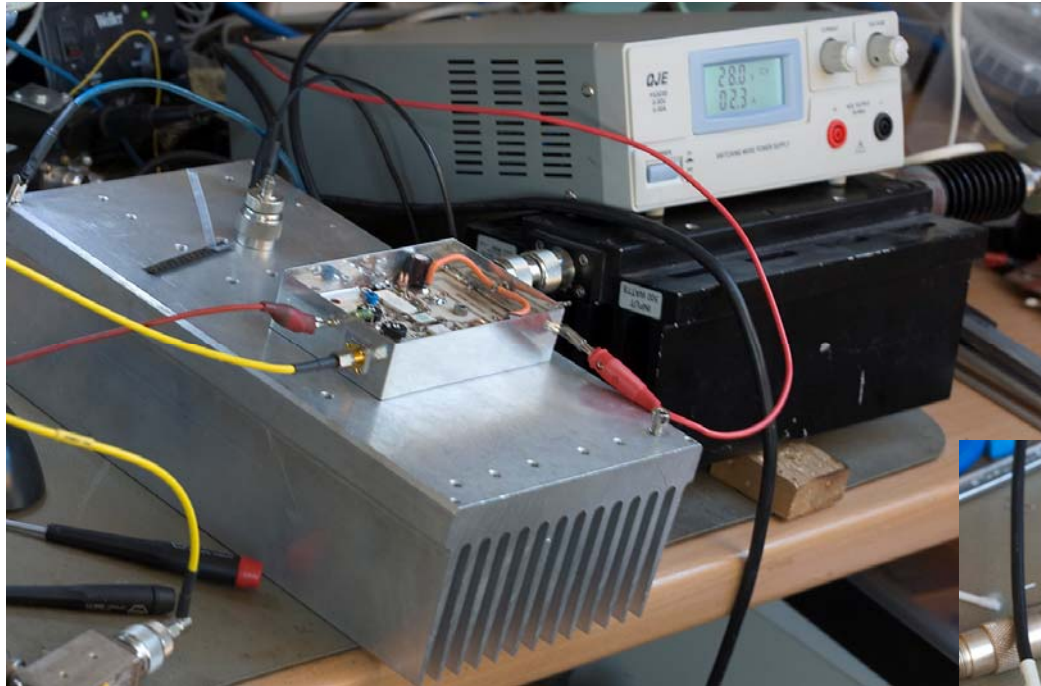

Use an isolator in the input during test and optimization

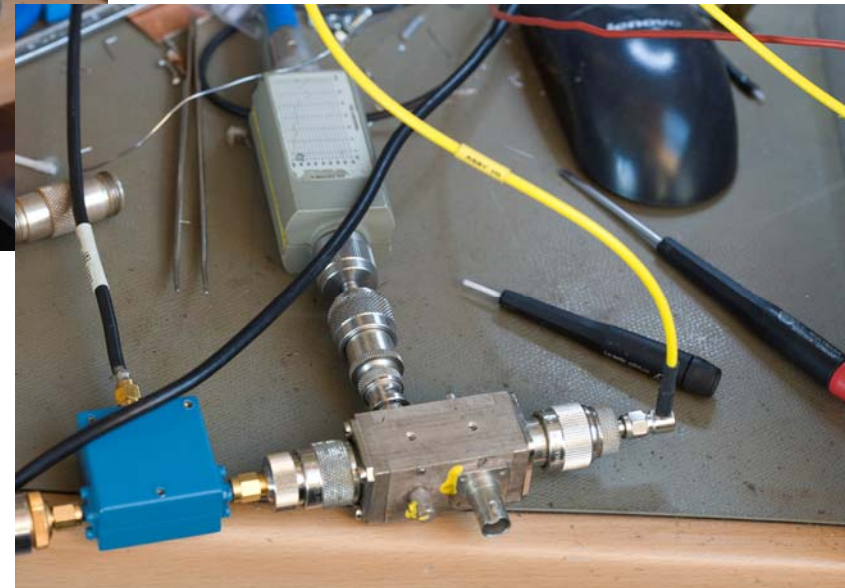

PA 1296 MHz: 2 x MRFE6S9160

2 x MRFE6S9160 1296 MHz

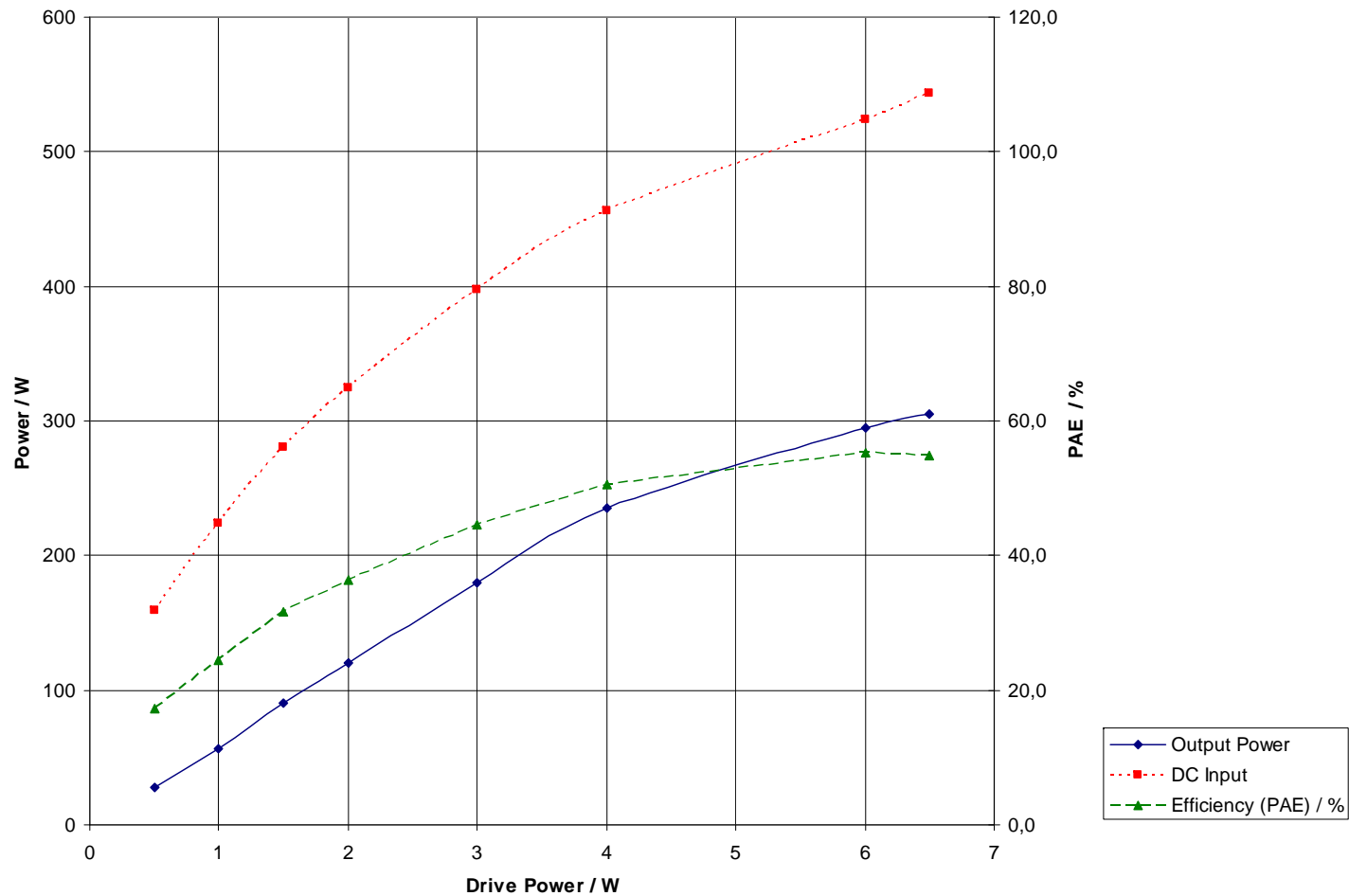

PA 1296 MHz: 2 x MRFE6S9160



- Result:
 - Small high-power boxed amplifier module
 - 275 W at 26 V – 305 W at 28 V – 340 W at 30,6 V
 - 17 dB gain
 - >50% efficiency
- Adjustment more difficult than with single transistor module
- For bigger PAs I prefer to combine twin modules externally

PA 1296 MHz: 2 x MRFE6S9160

- Next step: professional PCBs

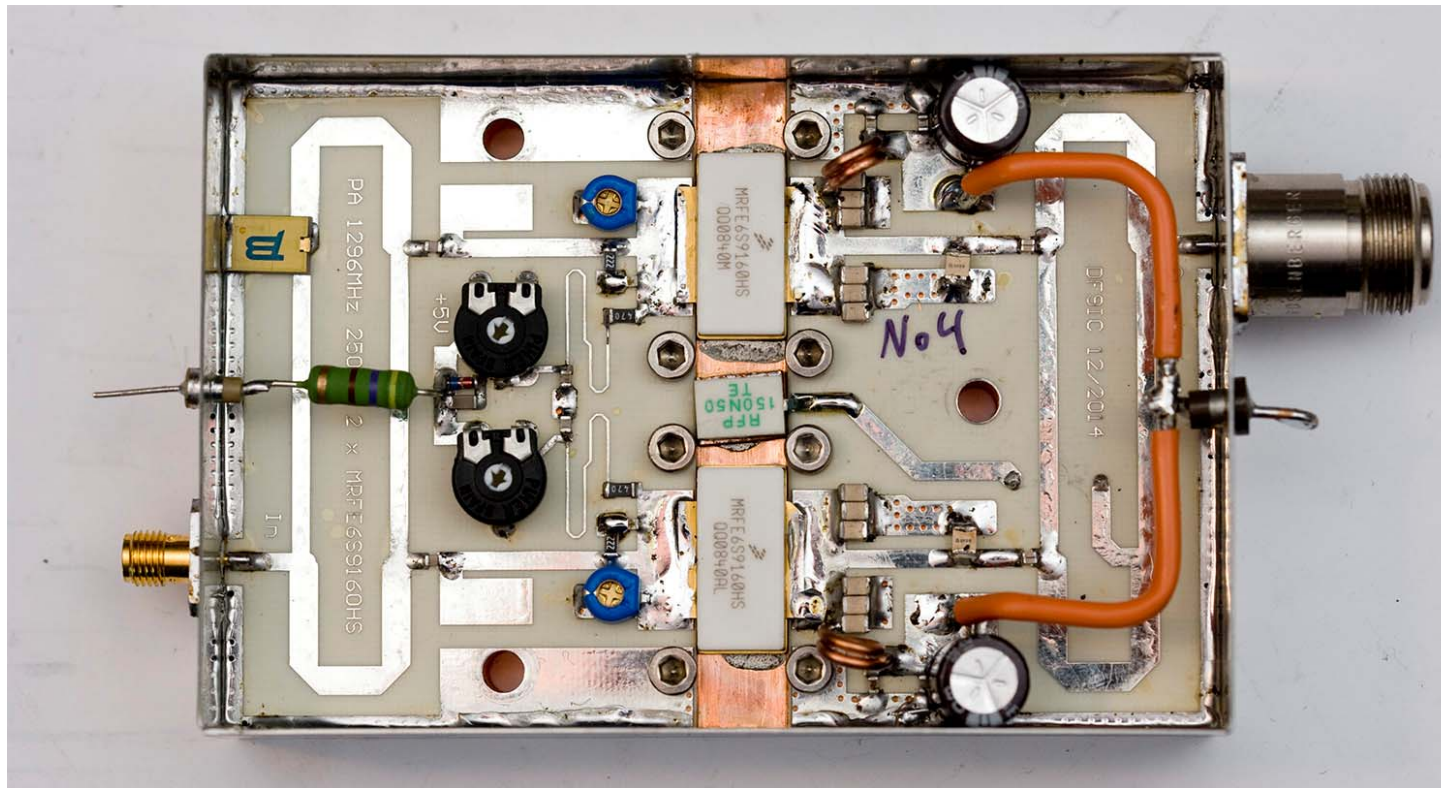

PA 1296 MHz: 2 x MRFE6S9160

- Variation of output tuning capacitor

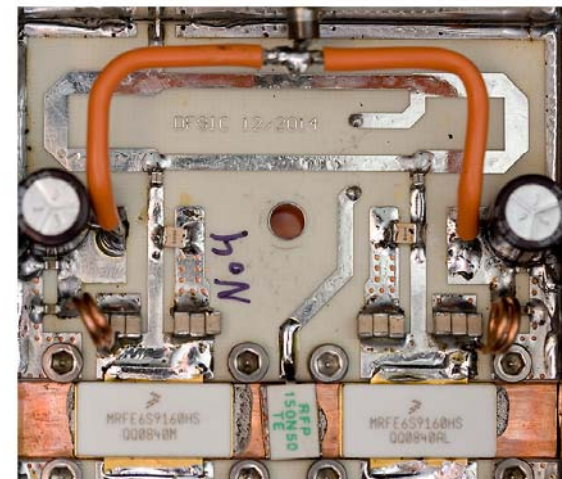
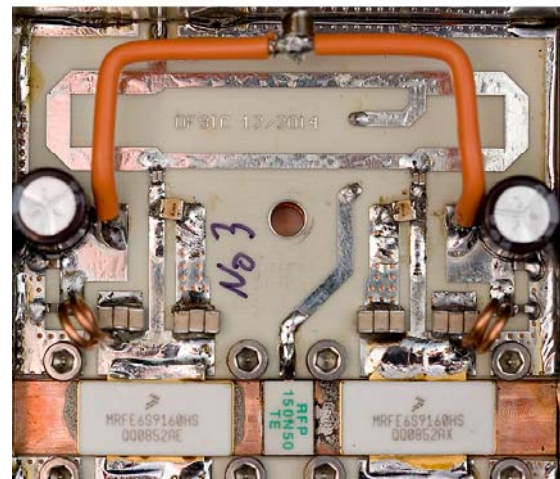
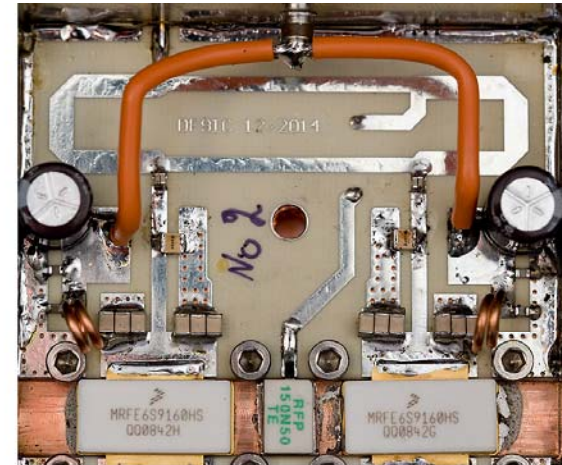
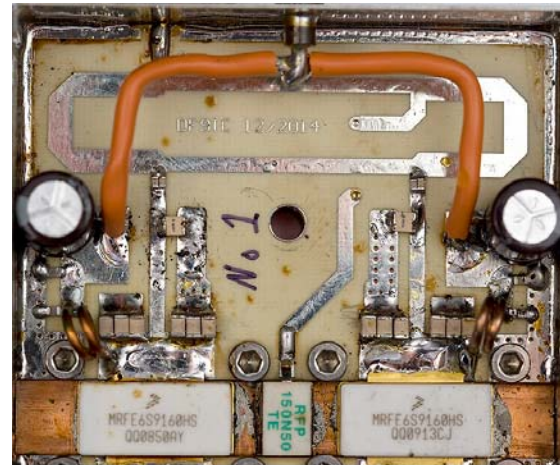

F5JWF: 4 x MRFE6S9160

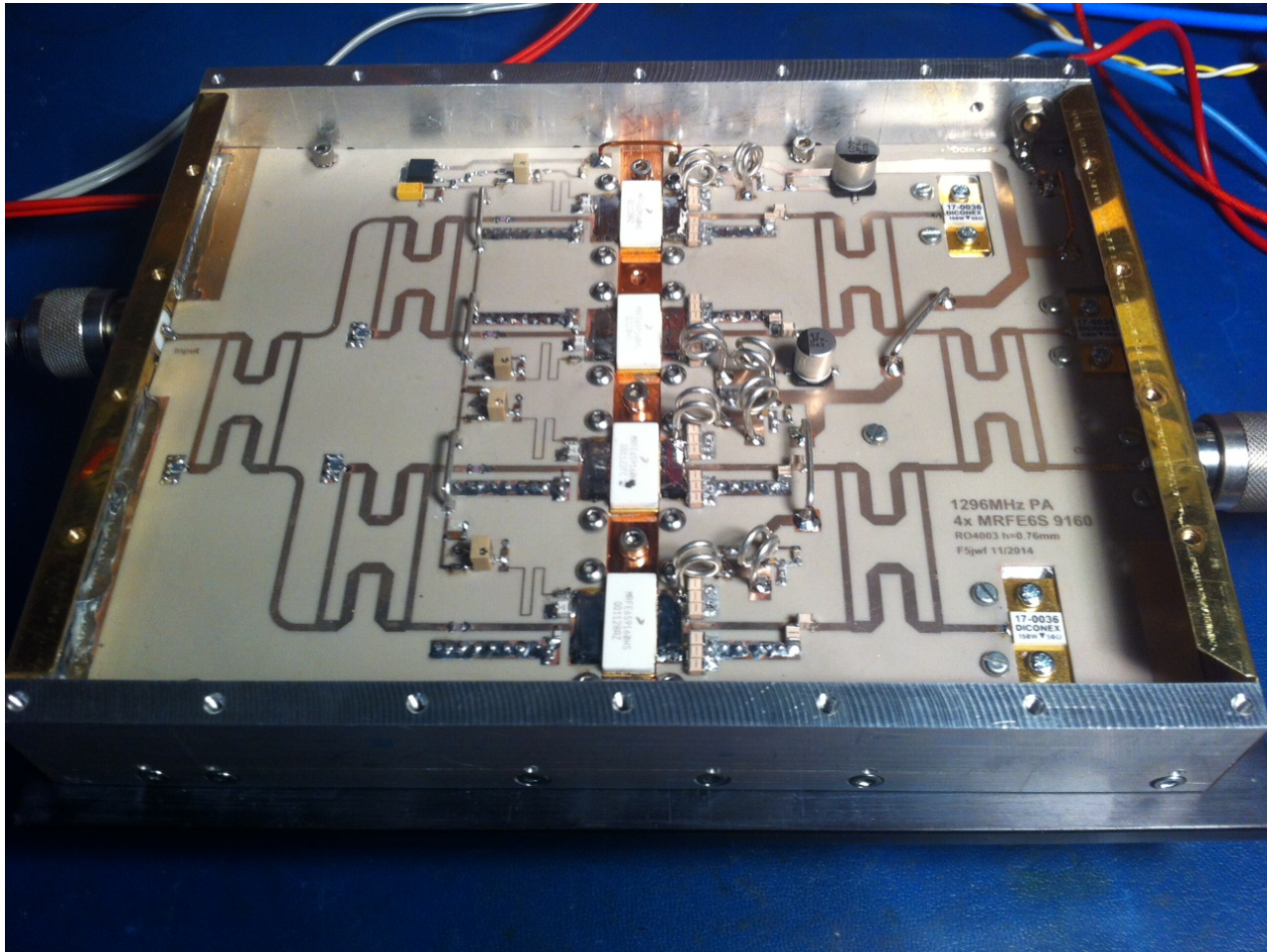

Based on the single transistor amp

Couplers and total design by Philippe F5JWF

F5JWF: 4 x MRFE6S9160



Nordic VUSHF 2016 Sappee

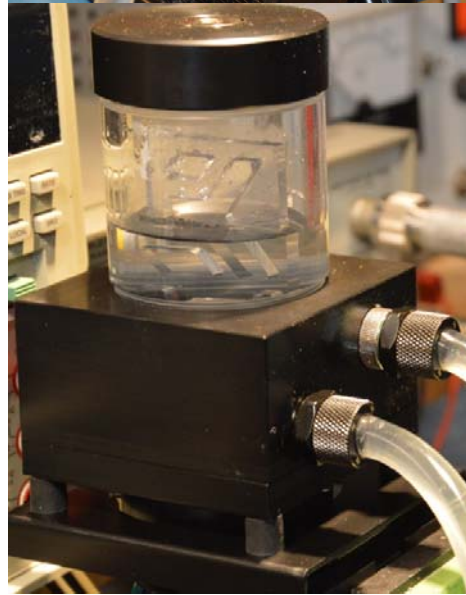
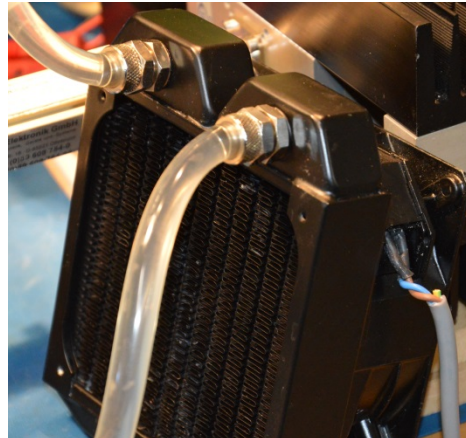

Wolf-Henning Rech DF91C

Efficient water cooling

$P_{\text{sat}} > 600 \text{ W}$

Philippe plans to mount two modules behind his dish feed for EME

How to make 1 kW on 1296?

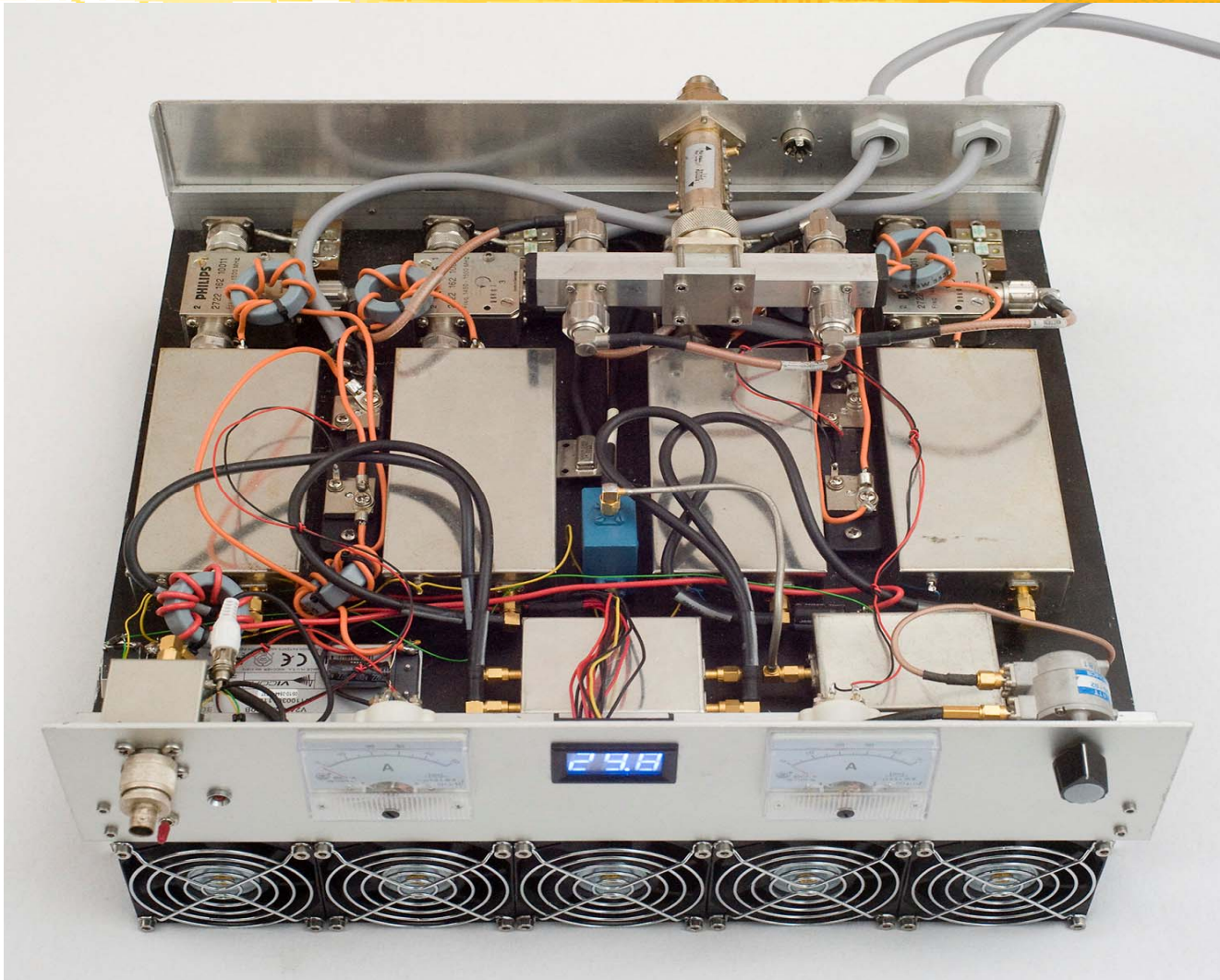

PA 1296 MHz: 8 x MRFE6S9160

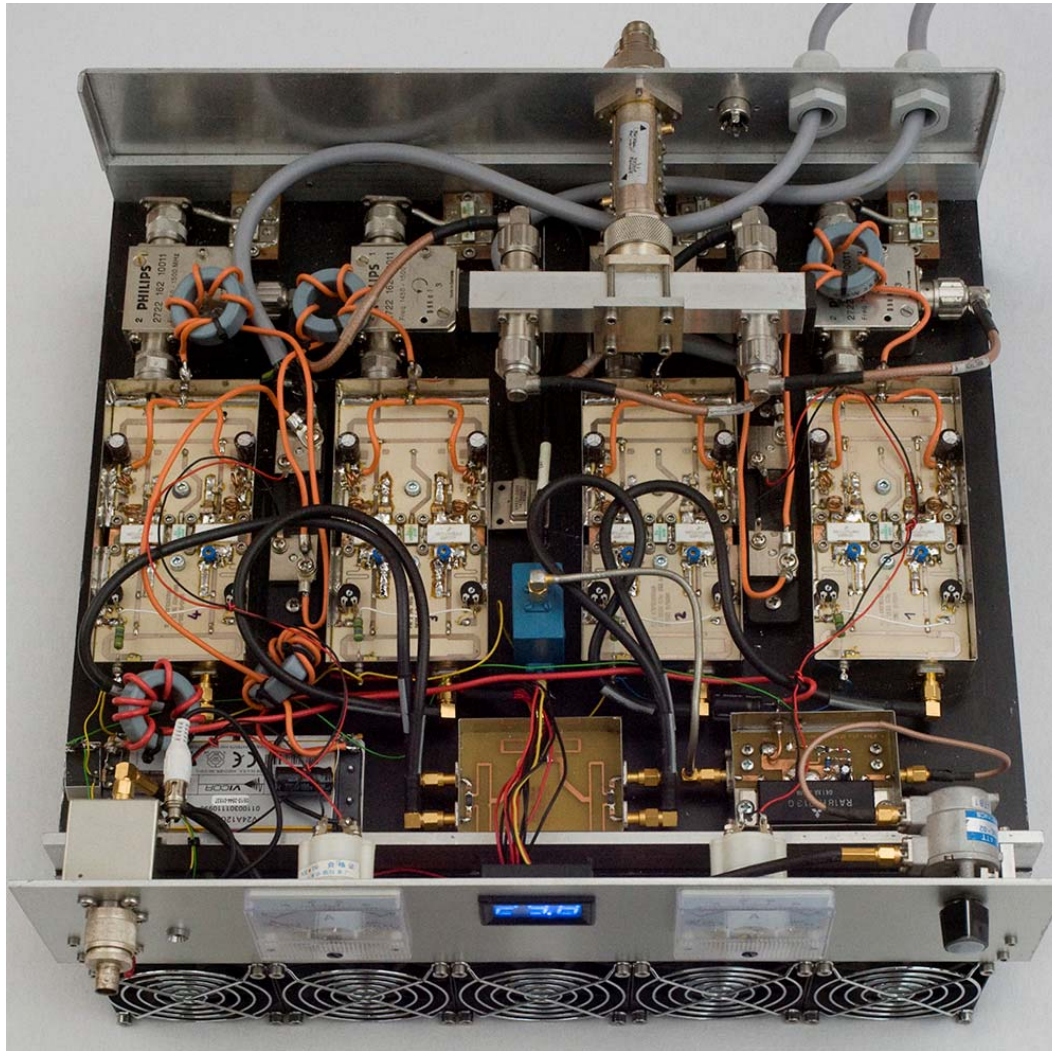

4 modules

Driver: RA18H1213
+ isolator

Input: Wilkinson
Coupler on FR4

Output: isolators +
non-isolated coupler
(antenna combiner)

PSU 28-30 V > 100 A

- 26 V / 150 A, but issues with pulse load SSB/CW



PSU 28-30 V > 100 A

- Server PSUs for 50 V and 12 V available, but not for 28 V

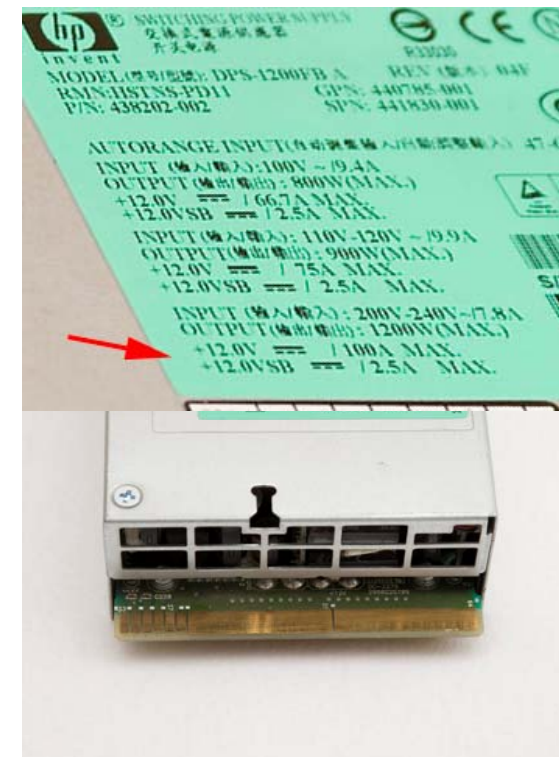

PSU 30 V > 100 A

Modifications:

- 12 V PSU to 10 V out
- Remove output grounding
- Add start-up resistor



PSU 30 V > 100 A

- Solution: use of 3 serially connected on the output, and supplied from 3 phase line power

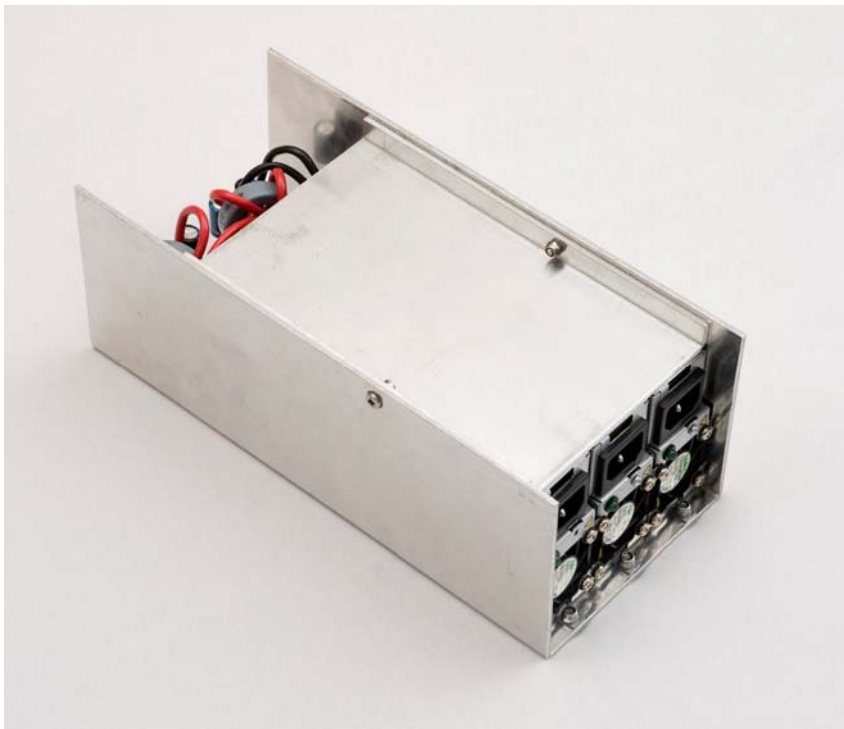

... and 2 kW?

- 8 x 1 Gysel combiner with 50 ohm 141 semirigid
- High RF current (20 A) at the combiner with 6.25 Ohm
- Lambda/4 transformer to 50 Ohm



Conclusion



- Concept of a 150 W 1296 MHz power amplifier module with a bill of material cost <50 EUR
- PA with 2 transistors in a box with printed couplers (min. 250 W for <100 EUR BOM)
- Higher power by combining multiple modules – 1 kW demonstrated